

7000 SERIES SPECIFICATIONS

designer blu-stone™ bathtubs

BT7000 | BT7010 | BT7020 | BT7030 | BT7040
BT7050 | BT7060 | BT7070 | BT7080

BATHTUB FEATURES:

- Base bathwell + custom side(s) make up each model
- Can be freestanding, alcove or recessed
- Streamlined, high profile one piece bathtub design
- Made of blu-stone™, providing the look and feel of natural stone
- Stronger and more durable than acrylic
- Non-porous, stain resistant surface that does not require sealing
- Does not promote bacteria, mold or fungi
- Includes integral slot overflow & matching blu-stone™ waste cover
- Extended side deck areas - suitable for deckmount faucet installation
- Versatile left-hand or right-hand drain installation
- Alcove installation requires separate tile flange, not included.
(Blu recommends TF.BTSB tile flange)
- Tailpiece not included

BATHTUB SPECIFICATIONS:

Basin Area: 65" (1650mm) x 25½" (650mm)*
Top Area: **MAX:** 86½" (2200mm) x 43¼" (1100mm)*
MIN: 70¾" (1800mm) x 31½" (800mm)*
To Overflow: 2½" (65mm)*
Water Depth: 14¼" (360mm)*
Capacity: 85G (322L)*
Slope of Backrest: 47°*
Hot water supply req'd: Should be 70% of water capacity of tub or greater
Warranty: Five Year Warranty (Residential use)
One Year Warranty (Commercial use)
Material: blu-stone™

BATHTUB FINISH:

White Matte

ACCESSORIES (sold separately):

- TF.BTSB tile flange for alcove installation

INSTALLATION NOTES:

Install this product according to the installation guide. Floor support under bath must provide for a minimum of 1400 lbs (635kg). Installation will vary. Our products must be installed by certified professionals only and according to our installation guide as well as federal, provincial / state a local building codes and regulations

CODES / STANDARDS APPLICABLE:

- Meets or exceeds ANSI / ASME standard
CSA B45.5.11 / IAPMO Z124
- IAPMO / ANSI Z124.8
- CSA



*Approximate measurements for comparison only.
Note: These dimensions and specifications are subject to change without notice.

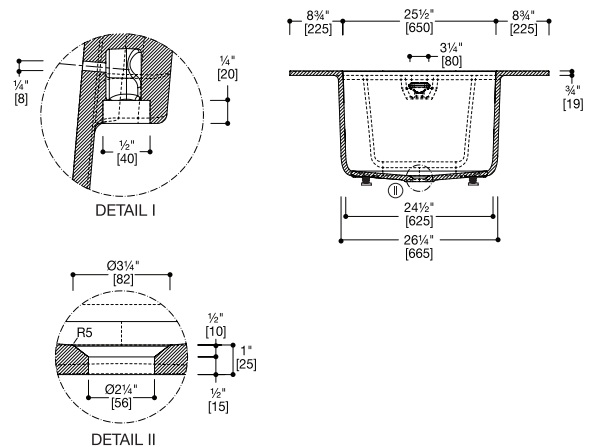
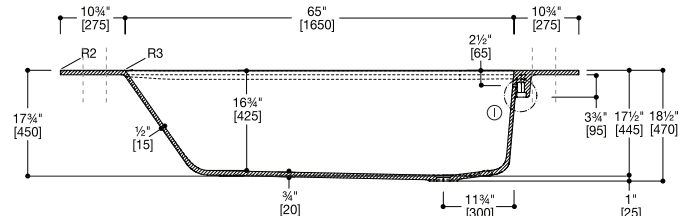
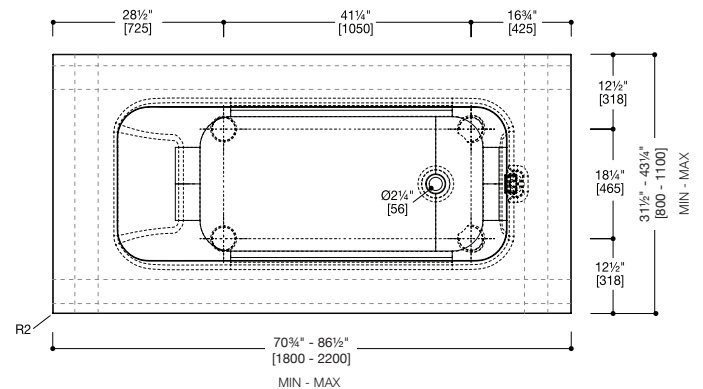

7000 SERIES SPECIFICATIONS

designer blu-stone™ bathtubs

BT7000 | BT7010 | BT7020 | BT7030 | BT7040

BT7050 | BT7060 | BT7070 | BT7080

BT7000

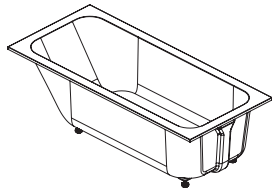

- Base unit
- No sides

BT7050-01M

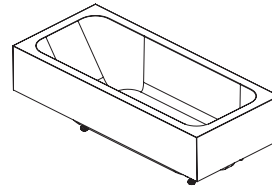

- Floor recessed
- 4 custom sides

BT7010

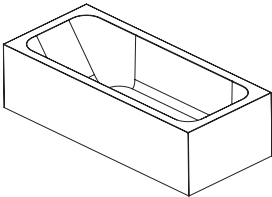

- Freestanding
- Finished 4 sides

BT7060

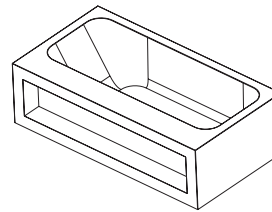

- Library A
- 1 front shelving unit
- + 2 sides + 1 end

BT7020

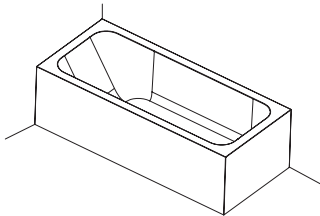

- Corner
- 1 front + 1 end

BT7070

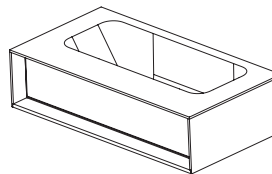

- Library B
- 1 front shelving unit
- + 2 sides + 1 end

BT7030

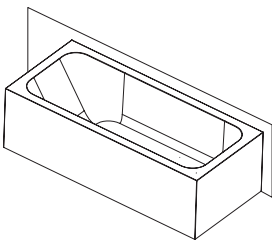

- Wall
- 1 front + 2 ends

BT7080

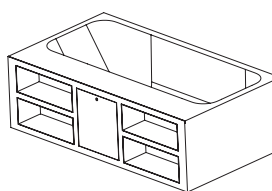

- Library C
- 1 front shelving unit
- + 2 sides + 1 end
- Includes magnetic door (BTDoor)

BT7040

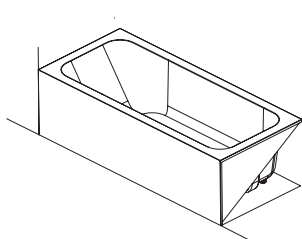

- Niche
- 1 front

BT7000

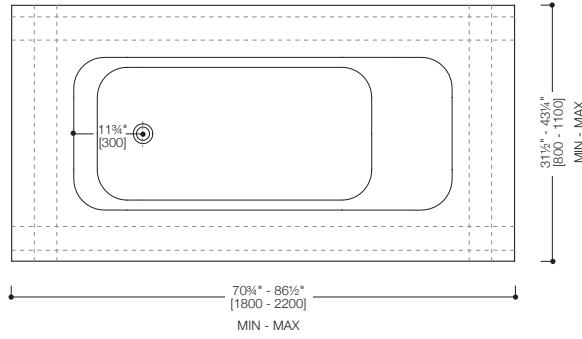
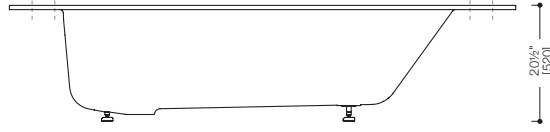
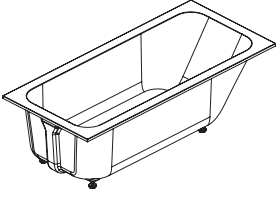

A	70 ³ / ₄ " L x 31 ¹ / ₂ " W x 20 ¹ / ₂ " H
B	78 ³ / ₄ " L x 39 ¹ / ₄ " W x 20 ¹ / ₂ " H
C	86 ¹ / ₂ " L x 43 ³ / ₄ " W x 20 ¹ / ₂ " H
D	MIN - MAX (L x W x 20 ¹ / ₂ " H)

- Base unit
- No sides

BT7010

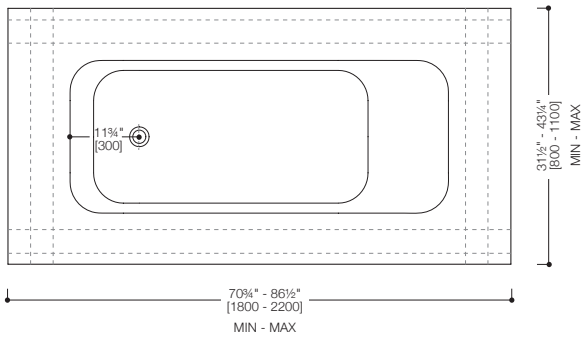
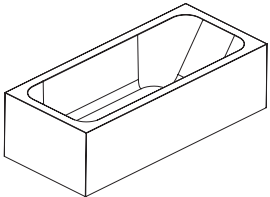

A	70 ³ / ₄ " L x 31 ¹ / ₂ " W x 20 ¹ / ₂ " H
B	78 ³ / ₄ " L x 39 ¹ / ₄ " W x 20 ¹ / ₂ " H
C	86 ¹ / ₂ " L x 43 ³ / ₄ " W x 20 ¹ / ₂ " H
D	MIN - MAX (L x W x 20 ¹ / ₂ " H)

- Freestanding
- Finished 4 sides

BT7020

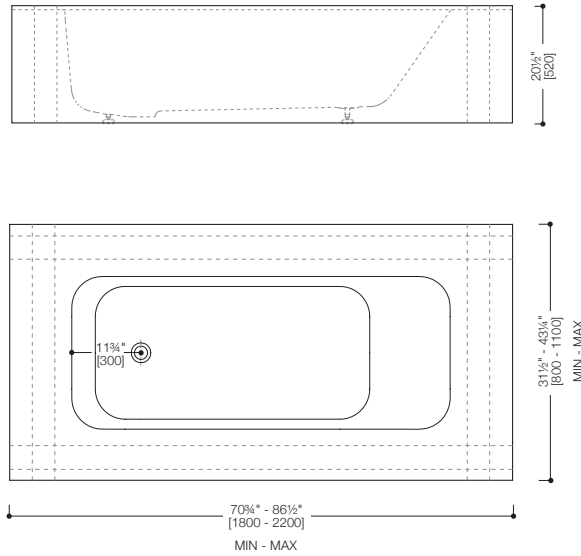
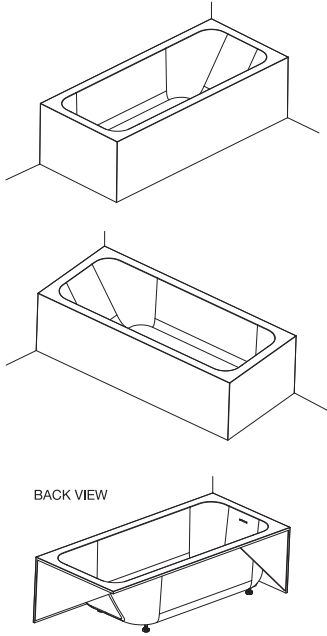

A	70¾" L x 31½" W x 20½" H
B	78¾" L x 39¼" W x 20½" H
C	86½" L x 43¼" W x 20½" H
D	MIN - MAX (L x W x 20½" H)

- Corner
- 1 front + 1 end

BT7030

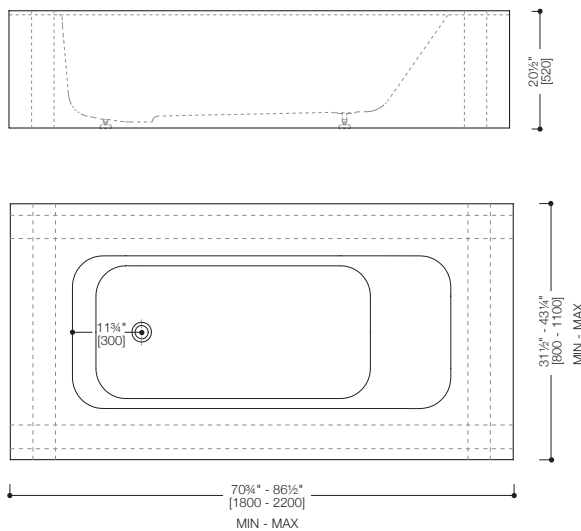
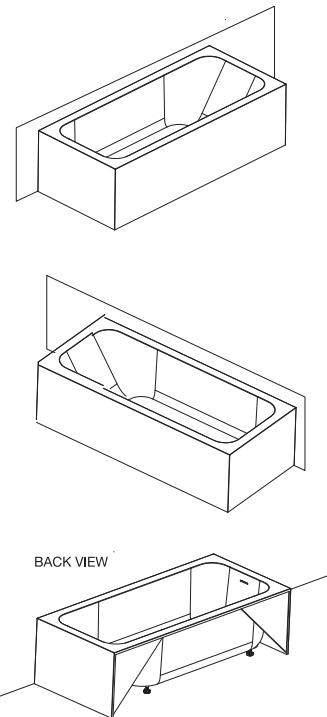

A	70" L x 31½" W x 20½" H
B	78¾" L x 39¼" W x 20½" H
C	86½" L x 43¼" W x 20½" H
D	MIN - MAX (L x W x 20½" H)

- Wall
- 1 front + 2 ends

BT7040

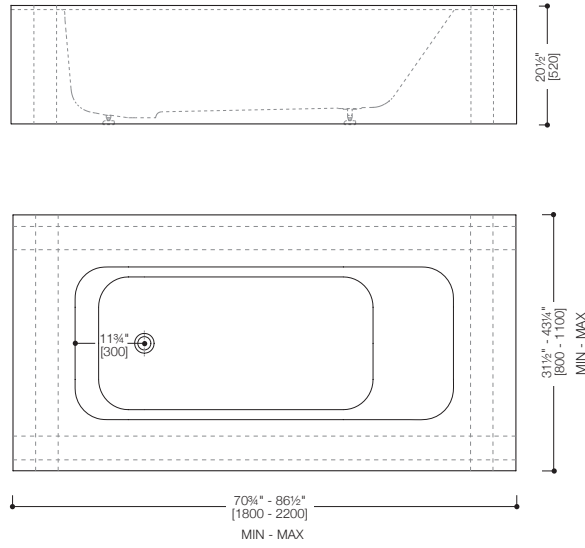
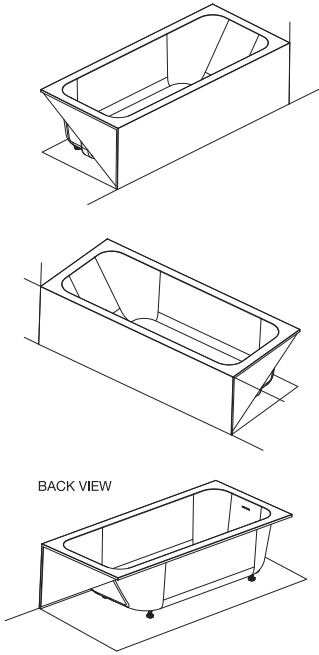

A	70¾" L x 31½" W x 20½" H
B	78¾" L x 39¼" W x 20½" H
C	86½" L x 43¼" W x 20½" H
D	MIN - MAX (L x W x 20½" H)

- Niche
- 1 front

BT7050

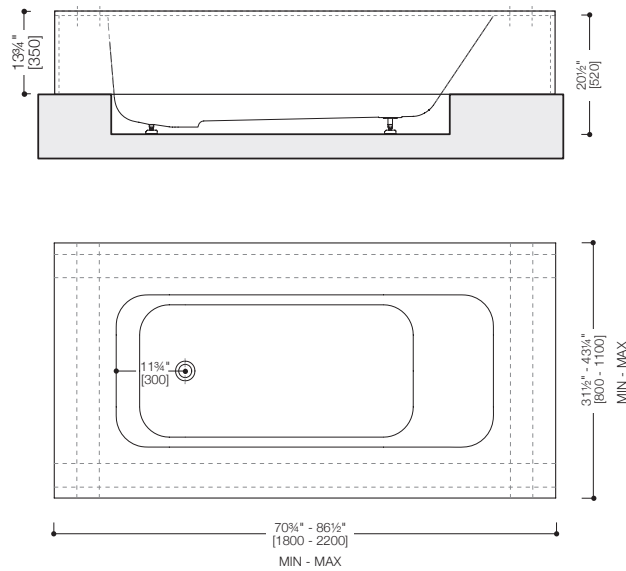
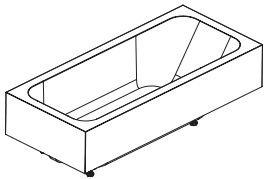

A	70¾" L x 31½" W x 20½" H
B	78¾" L x 39¼" W x 20½" H
C	86½" L x 43¼" W x 20½" H
D	MIN - MAX (L x W x 20½" H)

- Floor recessed
- 4 custom sides

BT7060

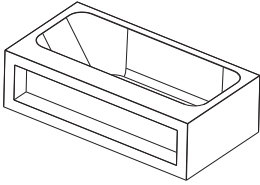
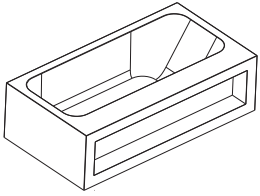

BACK VIEW

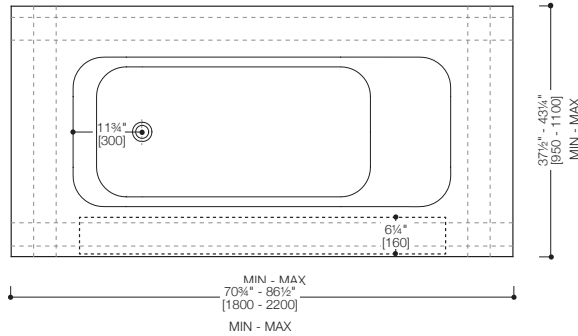
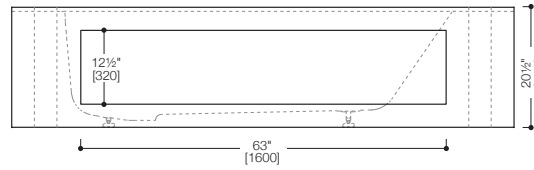
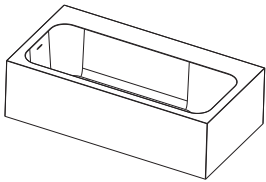

A	70¾" L x 37½" W x 20½" H
B	78¾" L x 41¼" W x 20½" H
C	82¾" L x 43¼" W x 20½" H
D	MIN - MAX (L x W x 20½" H)

- Library A
- 1 front shelving unit + 2 sides + 1 end

BT7070

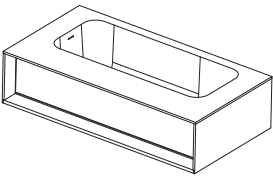
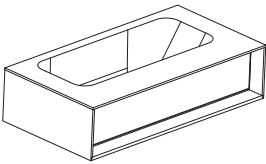

BACK VIEW

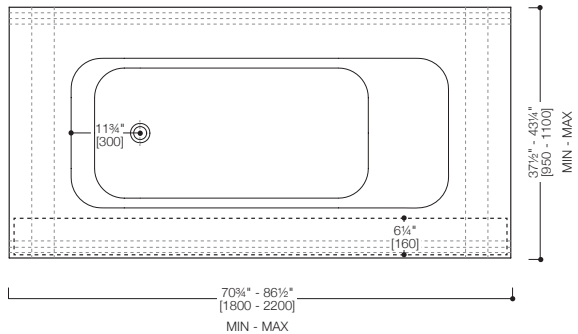
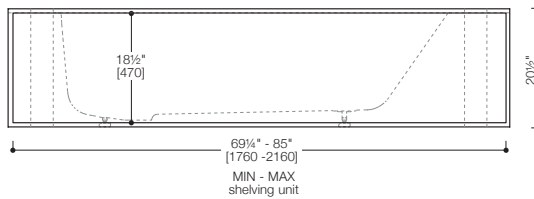
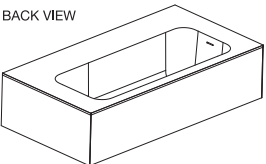

A	70¾" L x 37½" W x 20½" H
B	78¾" L x 41¼" W x 20½" H
C	82¾" L x 43¼" W x 20½" H
D	MIN - MAX (L x W x 20½" H)

- Library B
- 1 front shelving unit + 2 sides + 1 end

BT7080

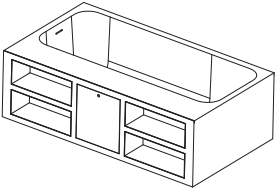
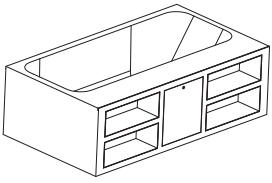

BACK VIEW

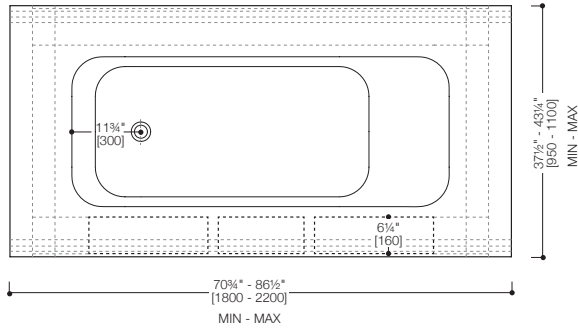
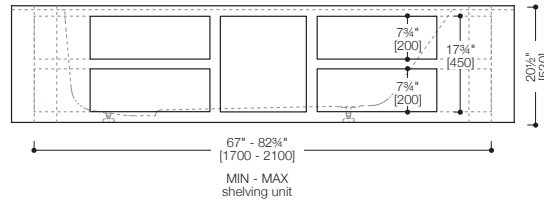
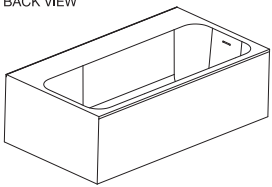

A	70 3/4" L x 37 1/2" W x 20 1/2" H
B	78 3/4" L x 41 1/4" W x 20 1/2" H
C	82 3/4" L x 43 1/4" W x 20 1/2" H
D	MIN - MAX (L x W x 20 1/2" H)

- Library C
- 1 front shelving unit + 2 sides + 1 end
- Includes magnetic door

BTDOOR

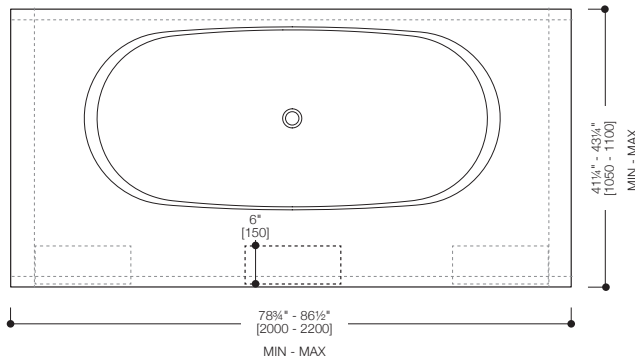
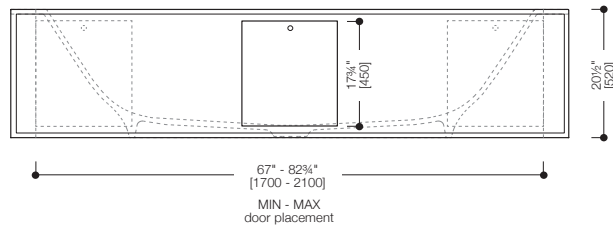
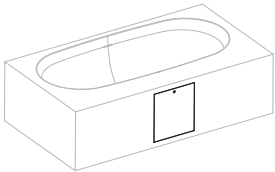

- Magnetic door option for BT7010, BT7020, BT7030, BT7040, BT7050 & BT7080
- Requires MIN bathtub width of 41 1/4" (1050mm)